

Sanitary partition wall type SVF30 JUMP

Cubicle system made of 30 mm chipboard

schäfer[®]
Trennwandsysteme



Stylish and elegant partitioning.



BEFORE WE
EXPECT TRUST FROM
OUR CUSTOMERS,
WE PROVIDE EVIDENCE
that's us!

ENVIRONMENT & SUSTAINABILITY *that's us!*

Sustainable management and careful use of resources are a matter of course for us and part of our corporate philosophy. This basic idea is consistently integrated and lived in our work processes. We are proud to be the first certified manufacturer of partition systems and lockers in Germany to operate according to the FSC™ and PEFC guidelines.

PEFC - registered

We pay attention to a sustainable supply chain in which our products are procured under ecological, economic and socially just aspects.

FSC™ - certified

As the first certified manufacturer in the area of partition systems and lockers in Germany, we make an active contribution to the protection of our earth with this future-oriented procurement method. We supply almost our entire range from sustainable wood in accordance with the specifications of the FSC™.



*On request
the products are
available with
FSC™ certification*

TÜV NORD GS TESTED SAFETY *that's us!*

Tested and certified by TÜV NORD these products meet the requirements of the Product Safety Act ProdSG § 21
Registration No. 44 329 14148802



MADE IN GERMANY *that's us!*

Our products are manufactured for you at the company site in Horhausen, Rhineland-Palatinate. This is the only way we can guarantee the high quality standards we set for our products.



PREQUALIFIED *that's us!*

We are registered in the list of prequalified construction companies with the number 010.049740, proving that we are qualified for the products and services we offer.



INNOVATIVE & DESIGN-ORIENTED *that's us!*

With our design-oriented and innovative products, we convince not only our customers, but also national and international committees.



reddot winner 2021





Floating toilet partitions.

The use of recessed supports and a recessed headrail gives a floating impression to the toilet partition wall SVF30 JUMP. This ensures a certain lightness and a lot of elegance in the sanitary room. A play of colours allows countless design possibilities and with motif prints, every partition becomes unique. SVF30 JUMP is ideal for the implementation of individual room concepts in dry WC rooms.



Interesting facts about SVF30 JUMP

WC partition walls made of 30 mm thick chipboard with ABS strips

- Recessed supports and headrail give a floating look
- Floor clearance ensures a quick and effective cleaning
- ABS strips in the same colour as the panels
- Wall connections are done as shadow gap
- Hardware made of anodized aluminium
- Flush fitted front on the outside of the cubicle
- Easy to clean and maintenance construction
- Suitable for dry rooms
- Large variety of decors and colours
- System will be produced acc. to the building site dimension







(1)
Privacy screens made of 13 mm solid grade laminate

- Wall-mounted privacy screens
- Revolving edge is always black
- Installed with durable aluminium holders
- Waterproof
- Wall-mounted structures without bottom support feet are particularly hygienic, since floor cleaning can then be faster and more efficient
- Wide range of colors available
- Motif prints are optionally available
- Privacy screens will be produced acc. to the building site dimension

(2) + (3)
Privacy screens made of 30 mm thick chipboard

- Wall-mounted privacy screens
- ABS strips and panels in the same colour
- Installed with durable aluminium holders
- Wall-mounted structures without bottom support feet are particularly hygienic, since floor cleaning can then be faster and more efficient
- Wide range of colors available
- Motif prints are optionally available
- Privacy screens will be produced acc. to the building site dimension





(1)

Handrail for toilet partition type SVF30 JUMP

- Matt, natural anodised
- Very easy to clean
- Integrated Free/engaged indicator (4)
- Emergency opening located in between– allows the locked door to be opened from the outside (5)
- Very good grip, because of the body-friendly shape

Possible Variation:

(1)

- Handrail adapted to the door length, always until the top edge of the door

(2)

- Handrail 55 x 1.150 mm

(3)

- Handrail 55 x 500 mm



(2)



(3)



Features type SVF30 JUMP

Head rail:



- Head rail recessed by 150 mm behind the front wall
- Aluminium brackets and angles ensure a stable construction

Supports:



- Dividing wall with recessed aluminium support
- Support holder made of anodised aluminium
- Stabilisation of the front elements by means of T-connectors under the dividing wall and front element, tightly screwed

Hinges:



- Stainless steel hinge with high-performance polymer
- Treads guarantee absolute freedom from maintenance and a silence closing of the door
- Without self-closing function (no extra charge)



- Aluminium hinge
- Running surface made of high-performance polymer
- Without self-closing function (no extra charge)
- With self-closing function (extra charge)
- Optionally available

Variations of accessories type SVF30 JUMP

Hardware:



Aluminium
door handle
Schäfer AL7050



Stainless steel
door handle
Schäfer ES6050



Nylon
door handle*
Schäfer N8051



Aluminium
one hand door knob
INSAFE



Aluminium
push handle SLIDESAFE

[To the handrail configuration online tool >](#)

[To the push handle SLIDESAFE >](#)

[To the one hand door knob INSAFE >](#)

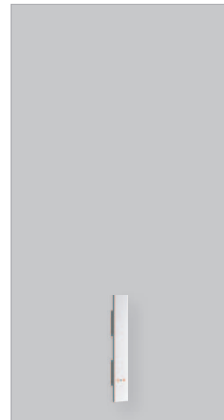

Aluminium handrail
55 x 500 mm
Schäfer ALGS1



Aluminium handrail
55 x 1.150 mm
Schäfer ALGS2



Aluminium handrail,
adapted to the door
length, always until the
top edge of the door
Schäfer ALGSV

[To the sanitary accessories >](#)



* All nylon finishes are available in RAL 9010 White and RAL 7038 Grey

Accessories for type SVF30 JUMP BLACKLINE

Fittings from the BLACKLINE design series can be selected as an option for type SVF30 JUMP.



BLACKLINE
aluminium one-hand door knob INSAFE
with clearly visible free-occupied indicator

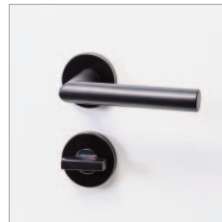

BLACKLINE
stainless steel door handle
with free-occupied locking device and emergency
opening slot on the outside of the cubicle

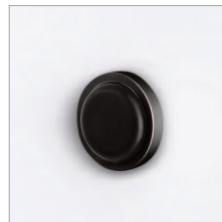

BLACKLINE
aluminium door buffer,
invisible fixation
Schäfer ALB5015



BLACKLINE
aluminium hook
Schäfer ALB5011



BLACKLINE
aluminium hinge
with self-closing function

Complete your BLACKLINE look.
Explore matching accessories now!

[To the sanitary accessories BLACKLINE >](#)



BLACKLINE

Colours type SVF30 JUMP

Panels:

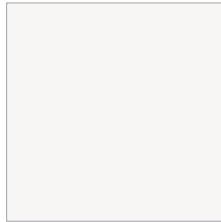

2001
Weiß

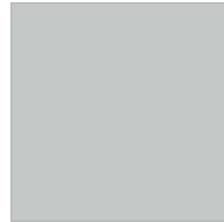

2002
Silbergrau

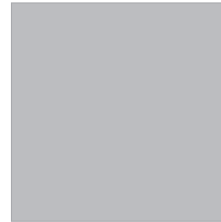

2010
Aluminiumgrau



2004
Anthrazit



2006
Limonengrün



2007
Atlantik



2008
Pflaume

ABS-strips:

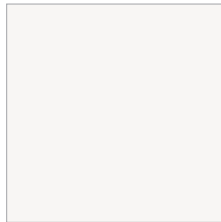

2001
Weiß



2002
Silbergrau

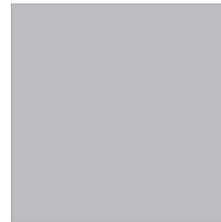

2010
Aluminiumgrau



2004
Anthrazit



2006
Limonengrün



2007
Atlantik



2008
Pflaume

Profiles:

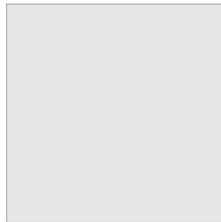

E6/EV1
Eloxiert

In the option with laminated panels (type SVF30S), the colours white (3001), anthracite (3004) and black (3009) are available.

Special colours for panels, ABS strips and profiles in all RAL colours and special accessories are available upon request. Ask us!

There may be a difference between printed colours and real colours.

Technical design of cubicle system type SVF30 JUMP

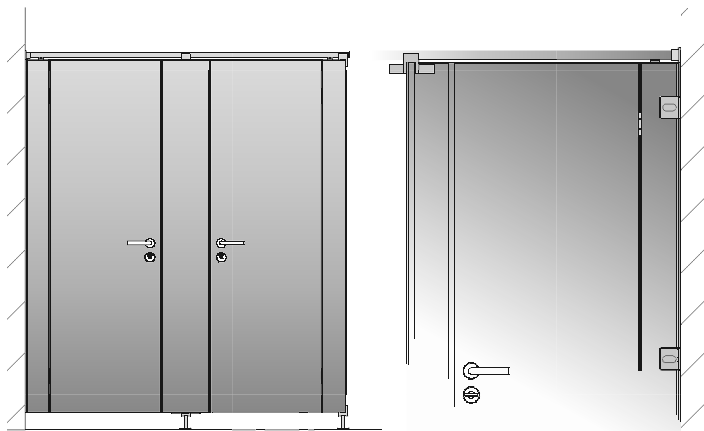
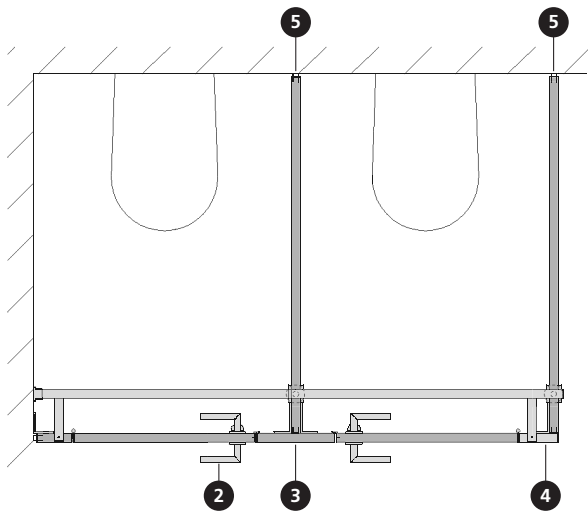

Because of the floating system, a stable wall connection of the front elements is essential.
Please note our technical sheet for details.

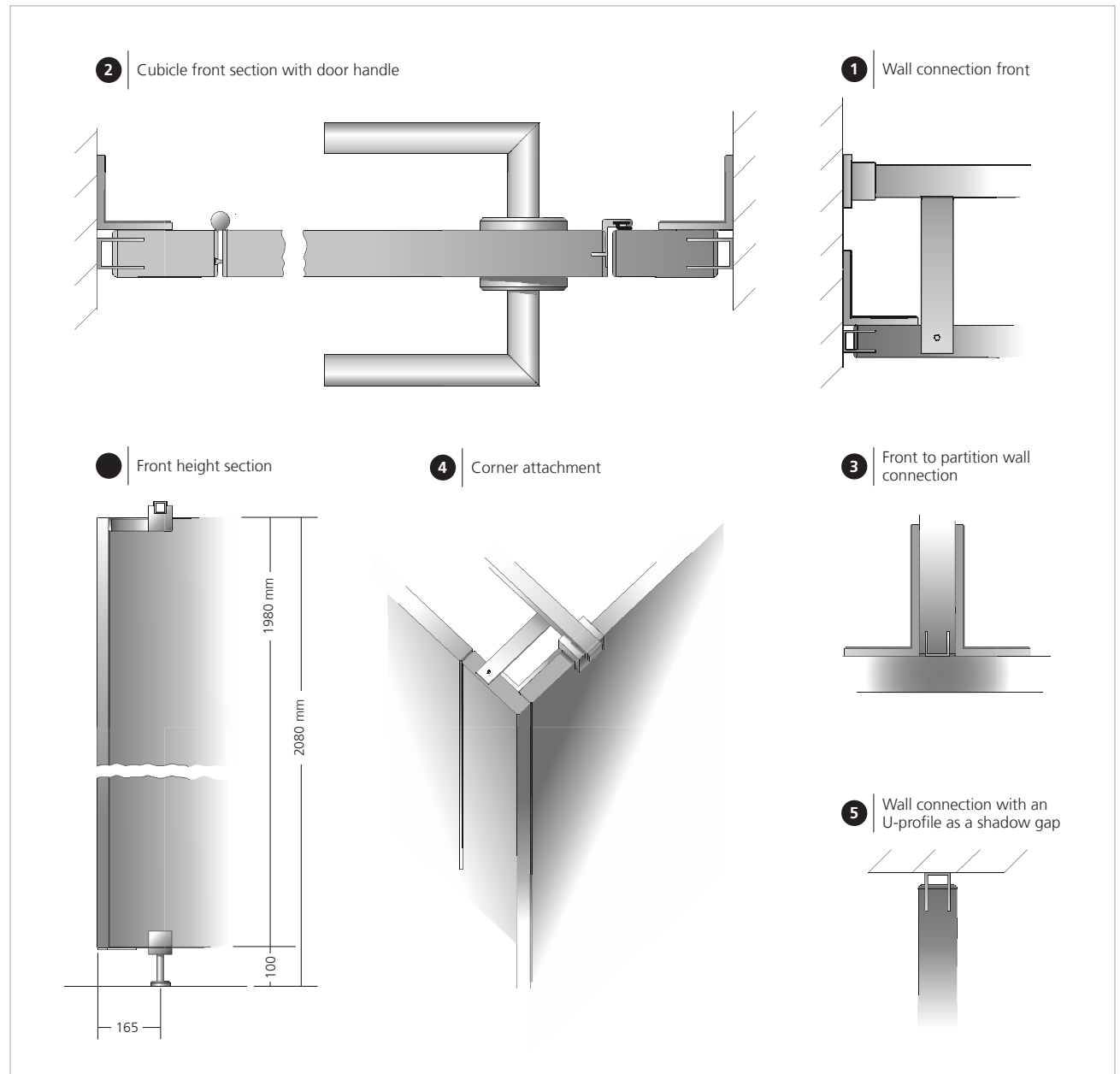

We reserve the right to make technical alterations.

