

# Sanitary partition wall type EF-3 JUMP

Sandwich elements with solid grade laminate surface

**schäfer**<sup>®</sup>  
Trennwandsysteme



Stylish and elegant partitioning.



BEFORE WE  
EXPECT TRUST FROM  
OUR CUSTOMERS,  
WE PROVIDE EVIDENCE  
*that's us!*

## ENVIRONMENT & SUSTAINABILITY

*that's us!*

Sustainable management and careful use of resources are a matter of course for us and part of our corporate philosophy. This basic idea is consistently integrated and lived in our work processes. We are proud to be the first certified manufacturer of partition systems and lockers in Germany to operate according to the FSC™ and PEFC guidelines.

### PEFC - registered

We pay attention to a sustainable supply chain in which our products are procured under ecological, economic and socially just aspects.

### FSC™ - certified

As the first certified manufacturer in the area of partition systems and lockers in Germany, we make an active contribution to the protection of our earth with this future-oriented procurement method. We supply almost our entire range from sustainable wood in accordance with the specifications of the FSC™.



On request  
the products are  
available with  
FSC™ certification

## TÜV NORD GS TESTED SAFETY

*that's us!*

Tested and certified by TÜV NORD these products meet the requirements of the Product Safety Act ProdSG § 21  
Registration No. 44 329 14148801.



## MADE IN GERMANY

*that's us!*

Our products are manufactured for you at the company site in Horhausen, Rhineland-Palatinate. This is the only way we can guarantee the high quality standards we set for our products.



## PREQUALIFIED

*that's us!*

We are registered in the list of prequalified construction companies with the number 010.049740, proving that we are qualified for the products and services we offer.



## INNOVATIVE & DESIGN-ORIENTED

*that's us!*

With our design-oriented and innovative products, we convince not only our customers, but also national and international committees.



red dot winner 2021





## Floating walls. Floating optics.

The EF-3 JUMP cubicle system impresses with its floating appearance. This gives the sanitary room a special lightness. It seems as if the system is floating. An optical highlight combined with an efficient side effect. Due to its construction, the WC partition wall is supported on recessed feet. The resulting floor clearance makes maintenance much easier. Cleaning can be carried out more quickly and therefore more efficiently. The recessed supports and headrail are the heart of this system in conjunction with the wall connections made as shadow gaps.



**Interesting facts about EF-3 JUMP**

**WC partition walls made of 36 mm thick sandwich elements with HPL surface**

- Recessed supports and headrail give a floating look
- No support feet visible in the front
- Floor clearance ensures a quick and effective cleaning
- Flush front
- Wall connections are done as shadow gaps
- Hardware made of high-quality anodised aluminium
- Fully waterproof construction
- Suitable for wet and dry areas
- Large variety of decors and colours
- Customised motif prints are possible
- System will be produced acc. to the building site dimension



#### Privacy screens

- Wall-mounted privacy screens
- Made of 13 mm solid grade laminate
- Revolving edge is always black
- Installed with durable aluminium holders
- Waterproof
- Wall-mounted structures without bottom support feet are particularly hygienic, since floor cleaning can then be faster and more efficient
- Wide range of colors available
- Motif prints are optionally available
- Privacy screens will be produced acc. to the building site dimension



(1)

**(1)**

- Construction here with integration of a toilet suitable for the disabled. The additional support leg under the side wall provides stability

**(2)**

- The INSAFE toilet lock with large red and white viewing window on the outside and inside of the cubicle gives the user a secure feeling of having locked the cubicle
- Particularly handy handle, very child-friendly to operate
- Made of robust and easy-care aluminium
- Large viewing windows make it easy to find a free cubicle

**(3)**

- Can be customised to suit any room situation
- Wider doors for people with disabilities
- Pictograms ensure easy orientation



(2)

(3)



(1)

### Handrail for toilet partition type EF-3 JUMP

- Matt, natural anodised
- Very easy to clean
- Integrated Free/engaged indicator (4)
- Emergency opening located below – allows the locked door to be opened from the outside (5)
- Optional available with LED
- Optional energy-saving LED strip shows the locking status clearly visible
- Very good grip, because of the body-friendly shape

### Possible Variation:

#### (1)

- Handrail adapted to the door length, always until the top edge of the door
- Optional available: in combination with a LED strip

#### (2)

- Handrail 55 x 1.150 mm
- Optional available: in combination with a LED strip

#### (3)

- Handrail 55 x 500 mm
- Optional available: in combination with a LED strip



(2)



(3)



## Features type EF-3 JUMP

### Headrail:



- Headrail recessed by 150 mm behind the front wall
- Aluminium brackets and angles ensure a stable construction

### Supports:



- Dividing wall with recessed aluminium support
- Support holder made of anodised aluminium
- Stabilisation of the front elements by means of T-connectors under the dividing wall and front element, tightly screwed

### Hinges:



- Anodised aluminium rising hinge with high-performance polymer
- Treads guarantee absolute freedom from maintenance and a silence, self-closing of the door
- Door hinges are generally used for door openings over 110°
- The hinges can optionally be fitted with a soft-close function



- Optional available: hinges located in the door rebate which ensure a complete flush front wall
- Optional available: internal tube door closer for a self-closing function of the door

## Variation of accessories type EF-3 JUMP

### Hardware:



Aluminium  
door handle  
Schäfer AL7050



Stainless steel  
door handle  
Schäfer ES6050



Nylon  
one hand door knob



Stainless steel  
one hand door knob



Aluminium  
one hand door knob  
INSAFE



Aluminium  
push handle SLIDESAFE

[To the handrail configuration online tool >](#)

[To the push handle SLIDESAFE >](#)

[To the one hand door knob INSAFE >](#)

[To the sanitary accessories >](#)

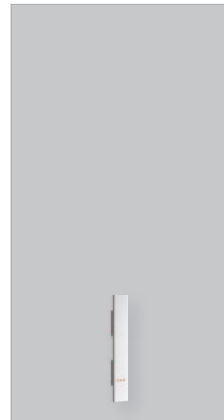

Aluminium handrail  
55 x 500 mm  
Schäfer ALGS1

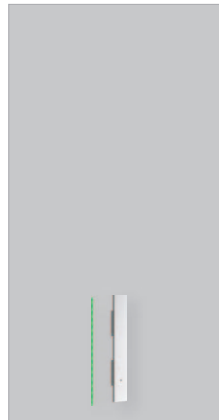

Aluminium handrail  
with LED strip  
55 x 500 mm  
Schäfer ALGS1 LED

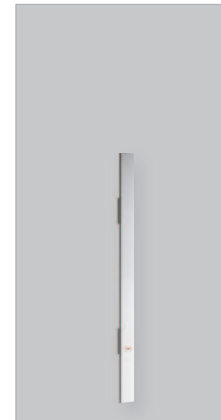

Aluminium handrail  
55 x 1.150 mm  
Schäfer ALGS2

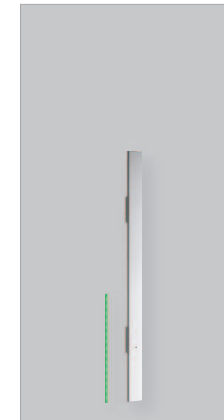

Aluminium handrail  
with LED strip  
55 x 1.150 mm  
Schäfer ALGS2 LED

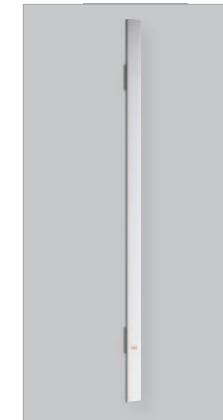

Aluminium handrail,  
adapted to the door  
length, always until the  
top edge of the door  
Schäfer ALGSV



Aluminium handrail with  
LED strip, adapted to the  
door length, always until  
the top edge of the door  
Schäfer ALGSV LED

### Buffer and hooks:



Aluminium buffer  
Schäfer AL7015



Stainless steel buffer  
Schäfer ES6015



Aluminium hook  
Schäfer AL7011



Stainless steel hook  
Schäfer ES6011

## Accessories for type EF-3 JUMP BLACKLINE

Fittings from the BLACKLINE design series can be selected as an option for type EF-3 JUMP.



BLACKLINE  
aluminium one-hand door knob INSAFE  
with clearly visible free-occupied indicator

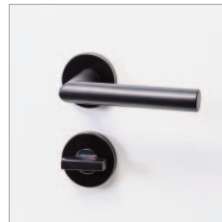

BLACKLINE  
stainless steel door handle  
with free-occupied locking device and emergency  
opening slot on the outside of the cubicle

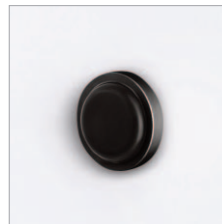

BLACKLINE  
aluminium door buffer,  
invisible fixation  
Schäfer AL7015S



BLACKLINE  
aluminium hook  
Schäfer AL7011S



BLACKLINE  
aluminium hinge  
with self-closing function



**BLACKLINE**

## Colours type EF-3 JUMP

### Panels:



2001  
Weiß

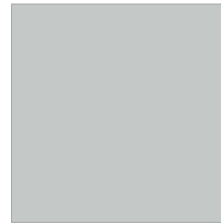

2002  
Silbergrau



2010  
Aluminiumgrau



2004  
Anthrazit



2006  
Limonengrün



2007  
Atlantik



2008  
Pflaume

### Profiles:

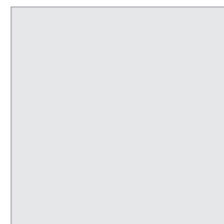

E6/EV1  
Eloxiert

Special colours for panels, wall-connection profiles in all RAL colours and special accessories are available upon request. Ask us!

There may be a difference between printed colours and real colours.

## Technical design of cubicle system type EF-3 JUMP

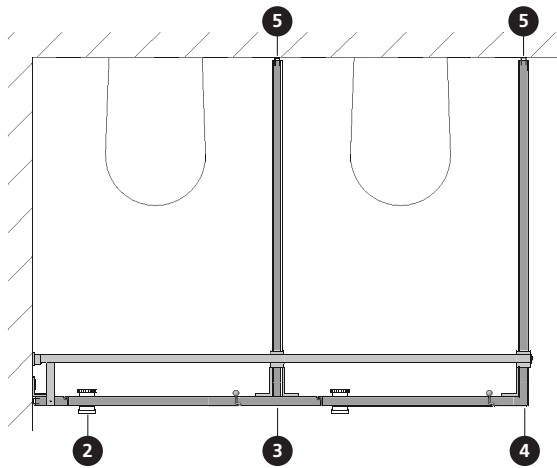

**2** Sectional view: front wall with one hand door knob  
Rising hinges made of aluminium

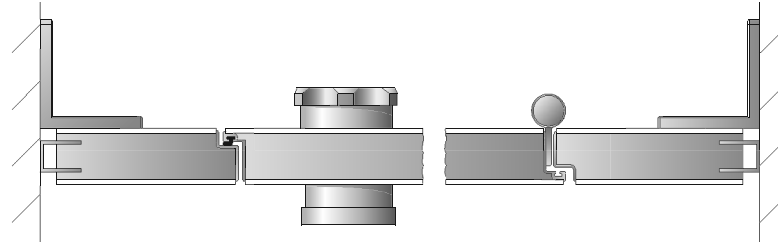

**3** Front to partition wall connection

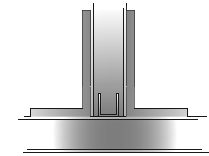

**1** Front height section

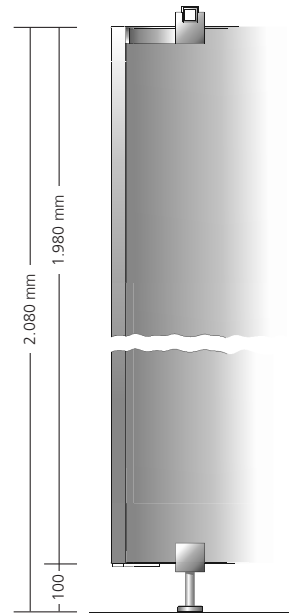

**4** Corner connection

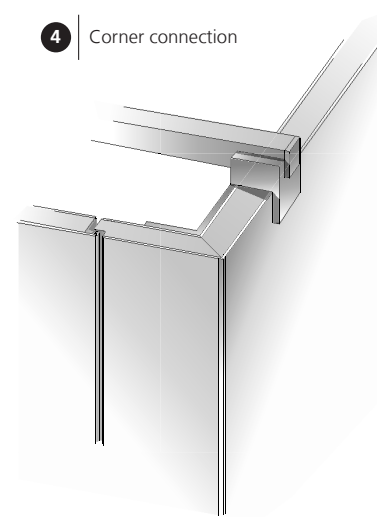

**5** Wall connection

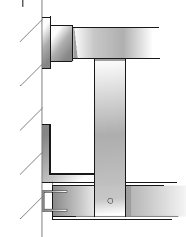

**5** Wall connection

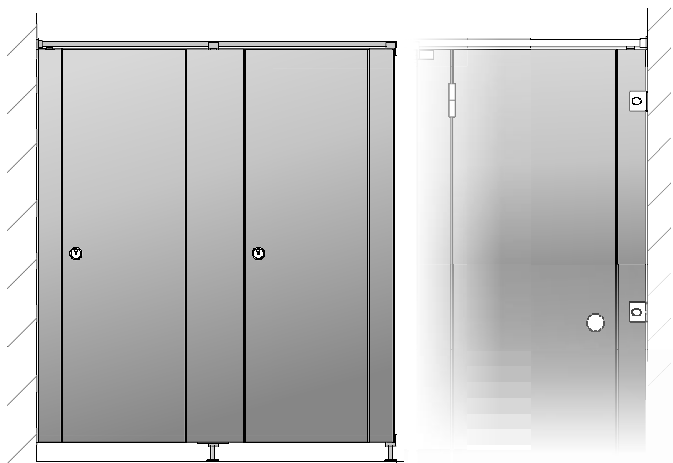
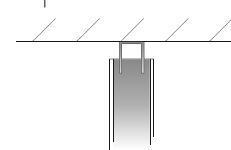

We reserve the right to make technical alterations.

